

شافيلىم مانگا

گۆست مانگا



لكاندن

سوهيل عبدالرزاق

وهرگـيـران

سوهيل عبدالرزاق

سپيكردهوه

سوهيل عبدالرزاق

پيداچوونهوه

ياد رۇوف

بهندي

17

THE HORIZON

ڪچهڪه و ڪورمڪه بهشي چوار

نووسراوه و وينهڪيشراوه
لهلايهن جي هون جيونگ



سووووش



کوٹاپی

ریگاگہ





كَيْفَ
يَكُونُ

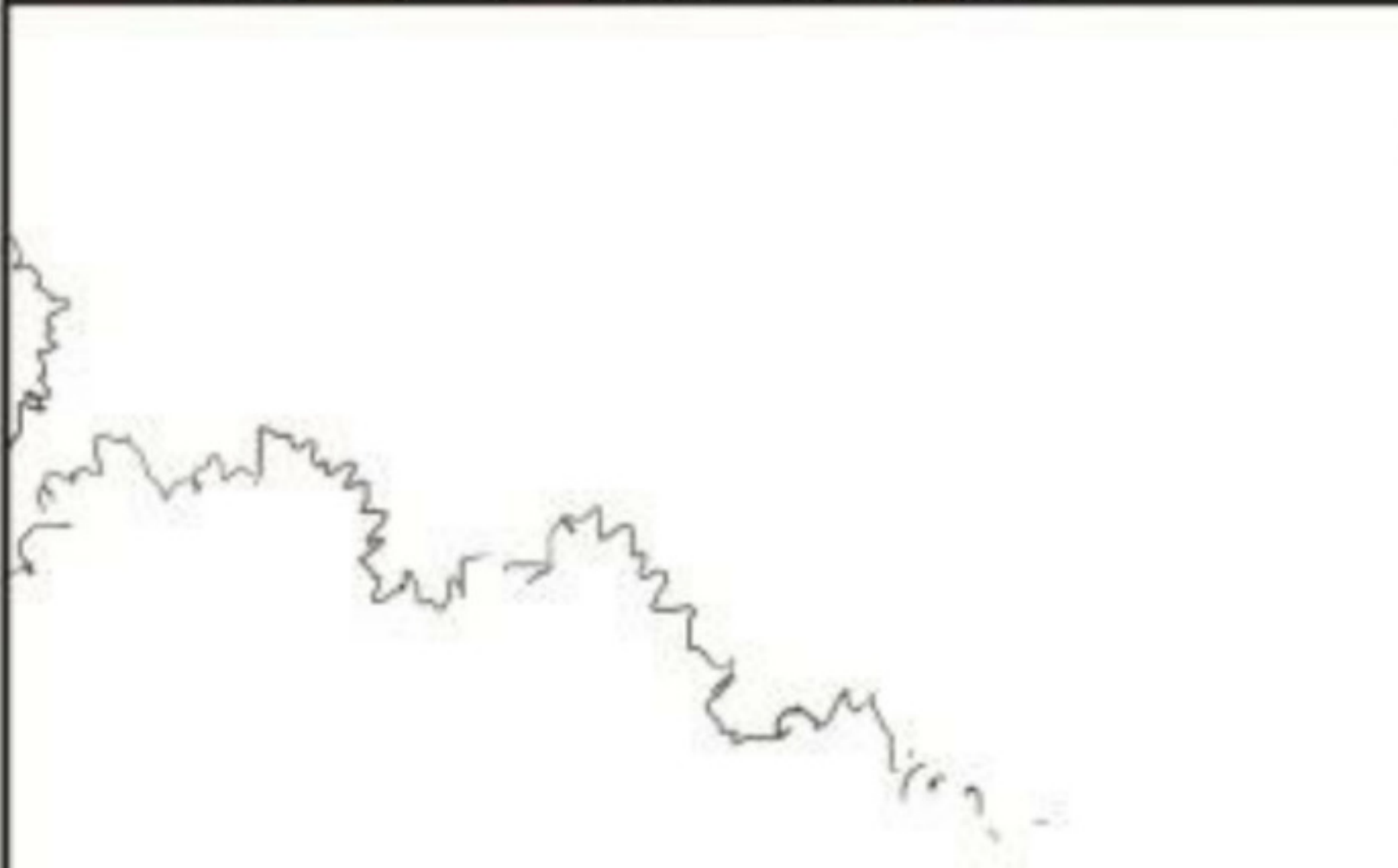
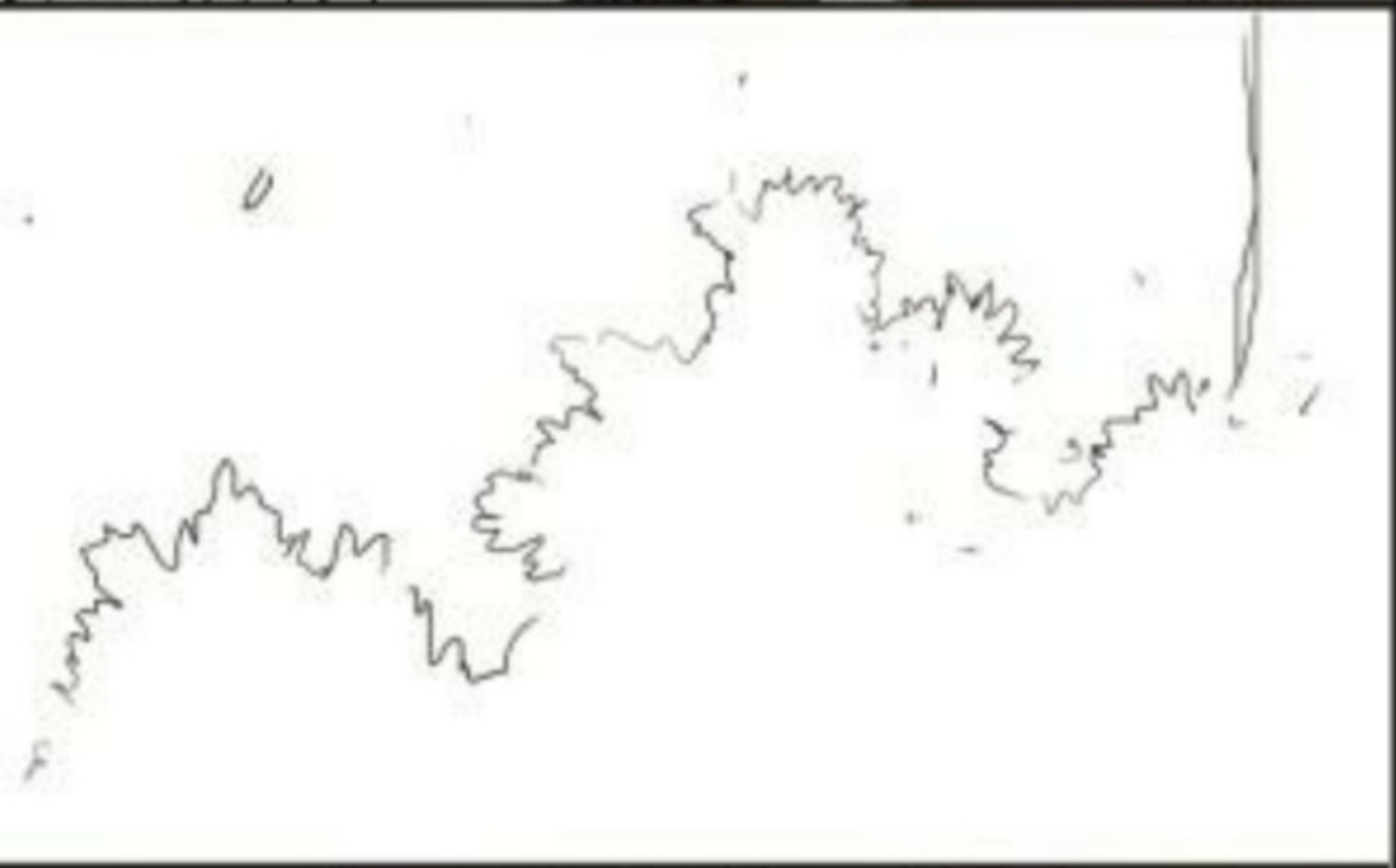







رېځاګه به هیواشی دیار
ناهییت



نيگه ران مه به



به رده مار ده بين له
رؤيشتن به ره و پيشه وه



ئيمه هه موومان بۇ كوئ ده چين؟



بەرەو شوپنیک



ئەجولپین



ھەنگا ھەنگا





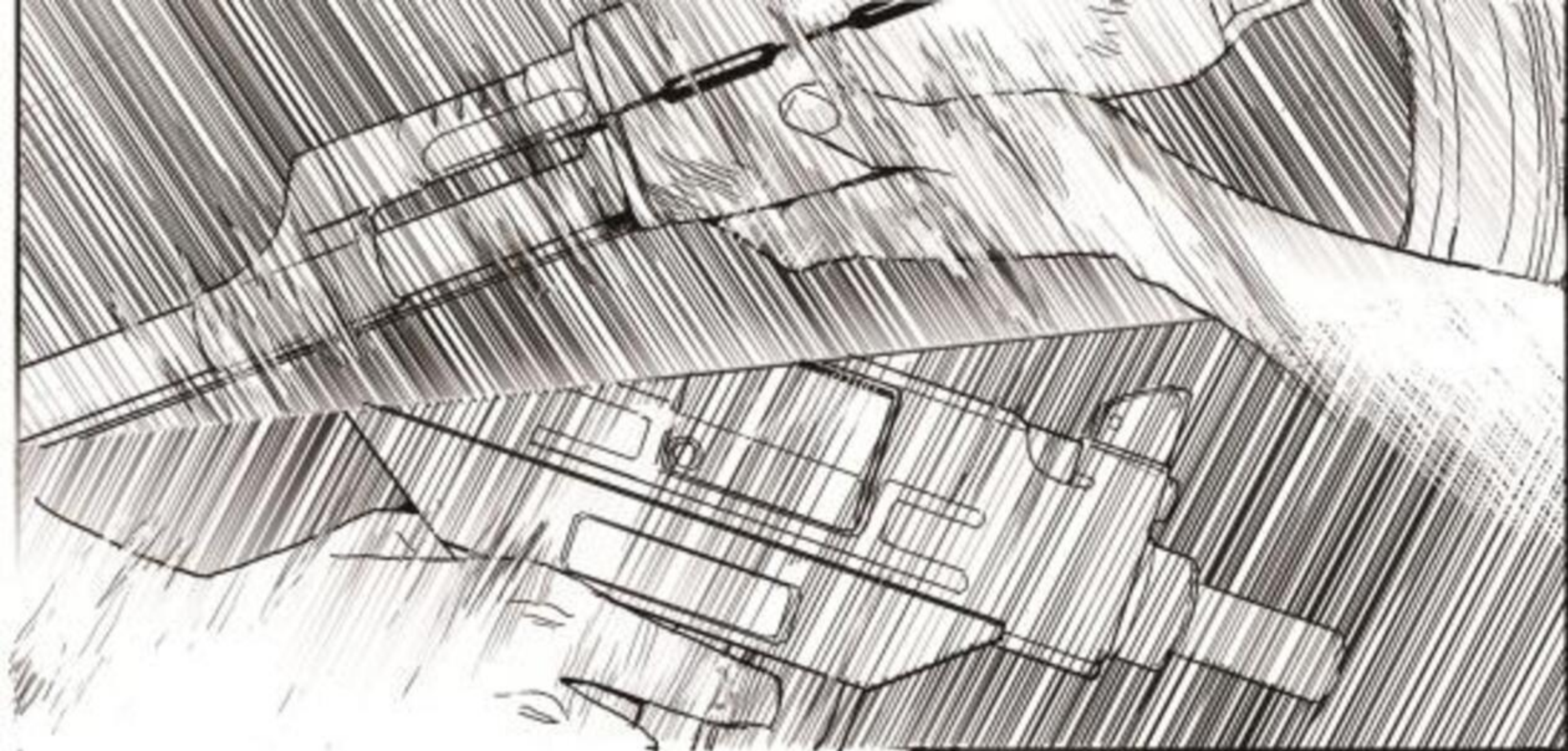

بۇچى جيمان بەر شىۋەيەيە؟



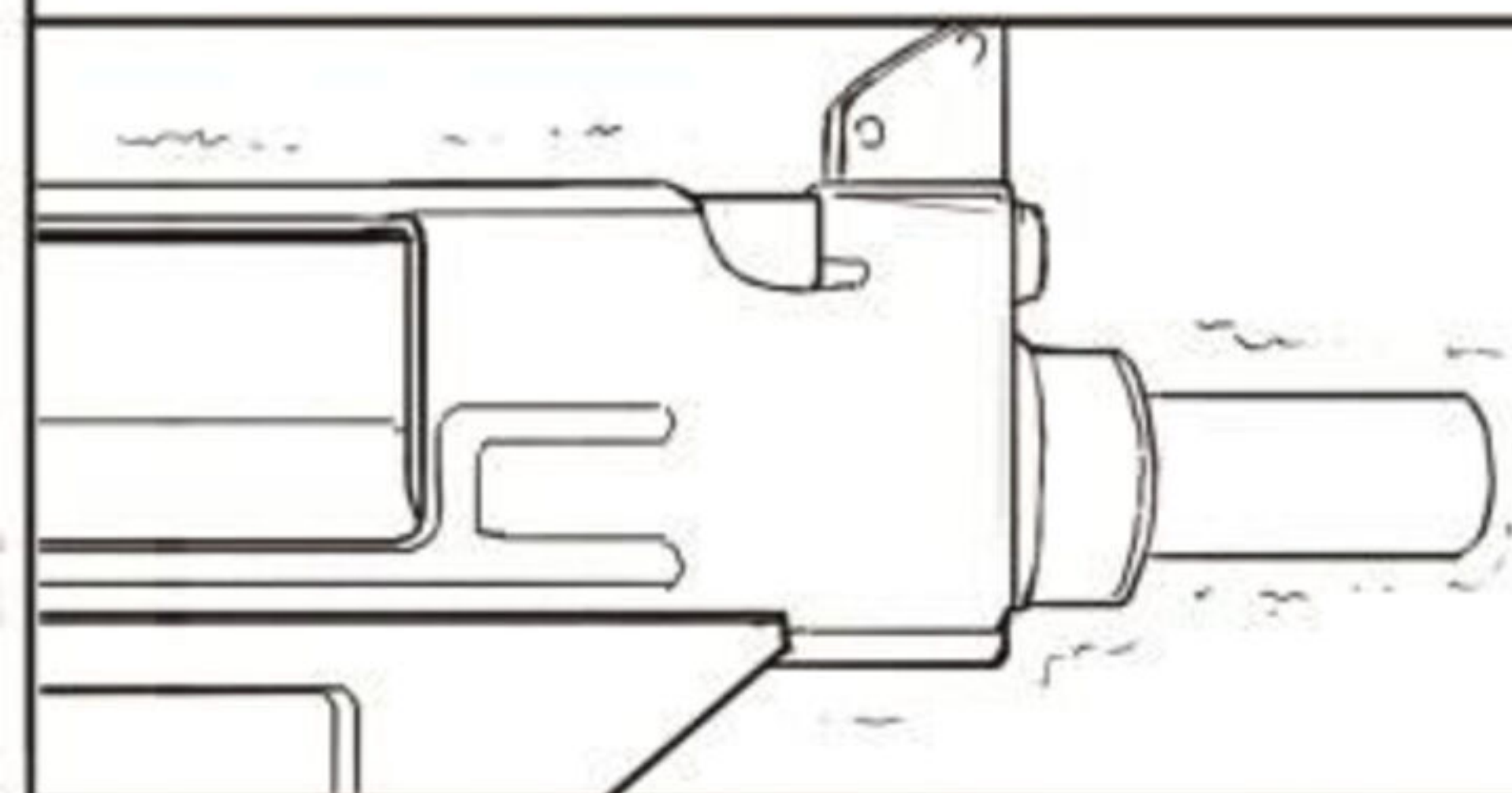
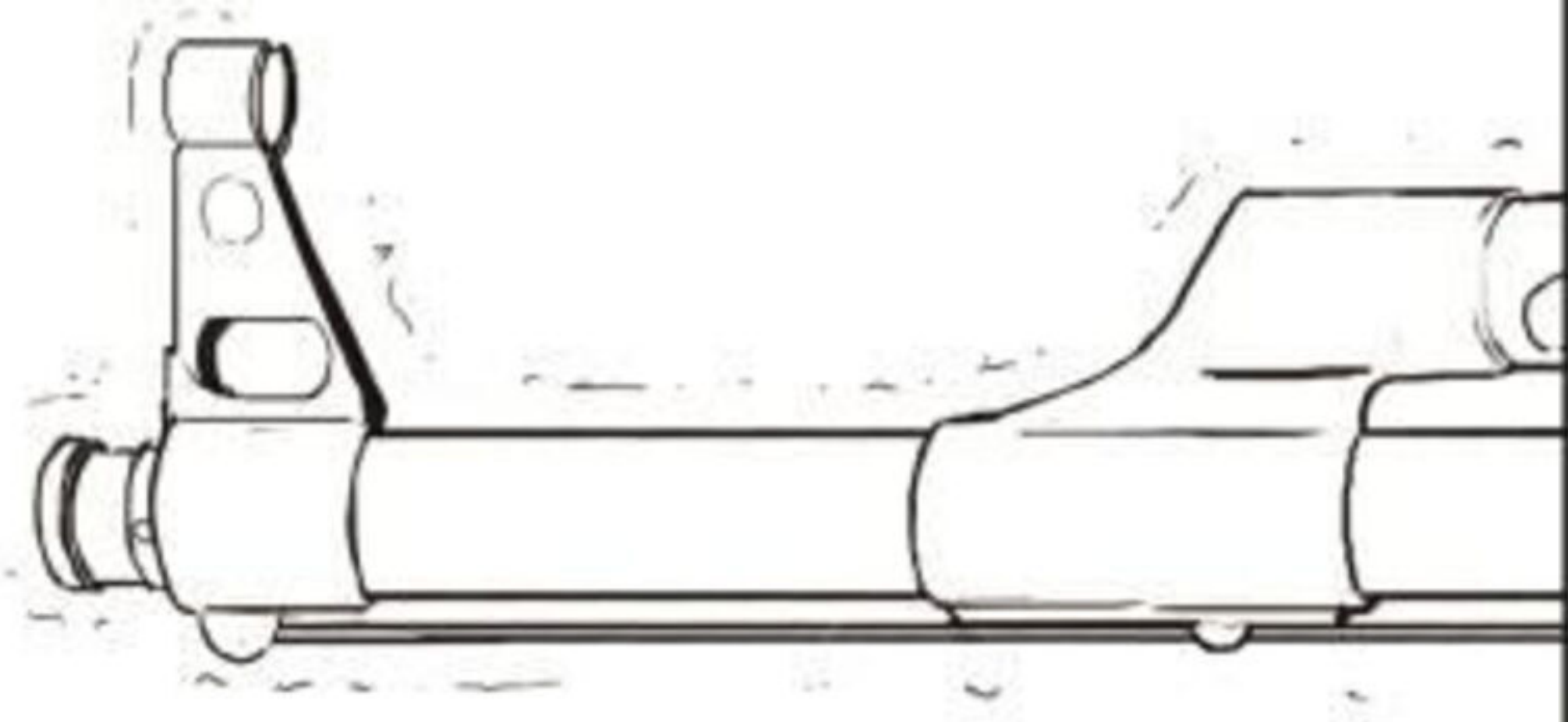





پہلے کہے۔
کہتے
نرمبیکہ
وہ!!



وقتی بچه که گات نزمبکه وه!

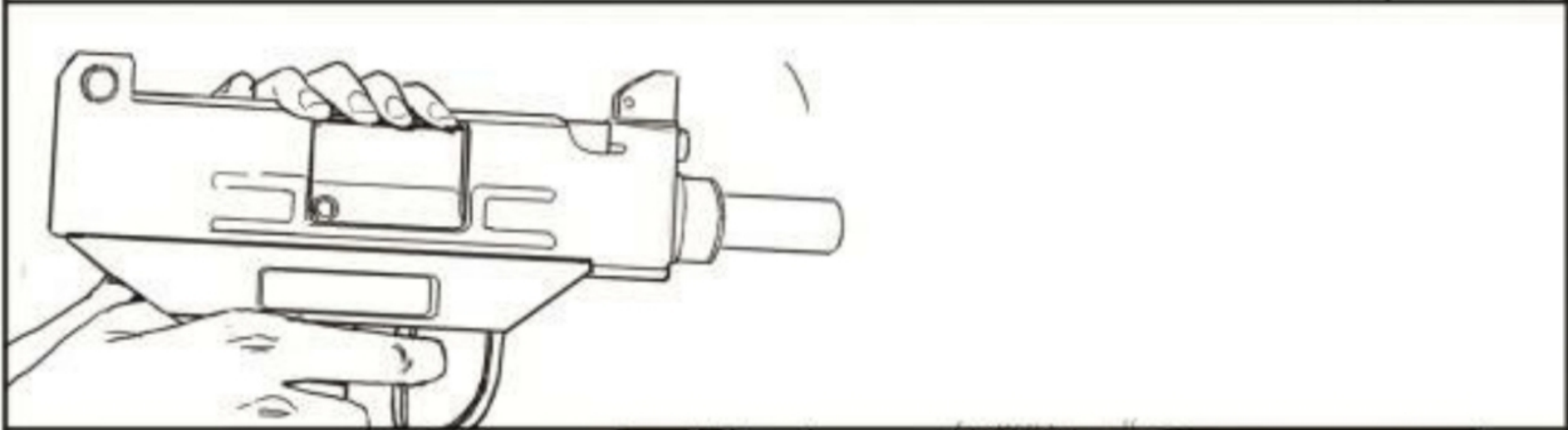
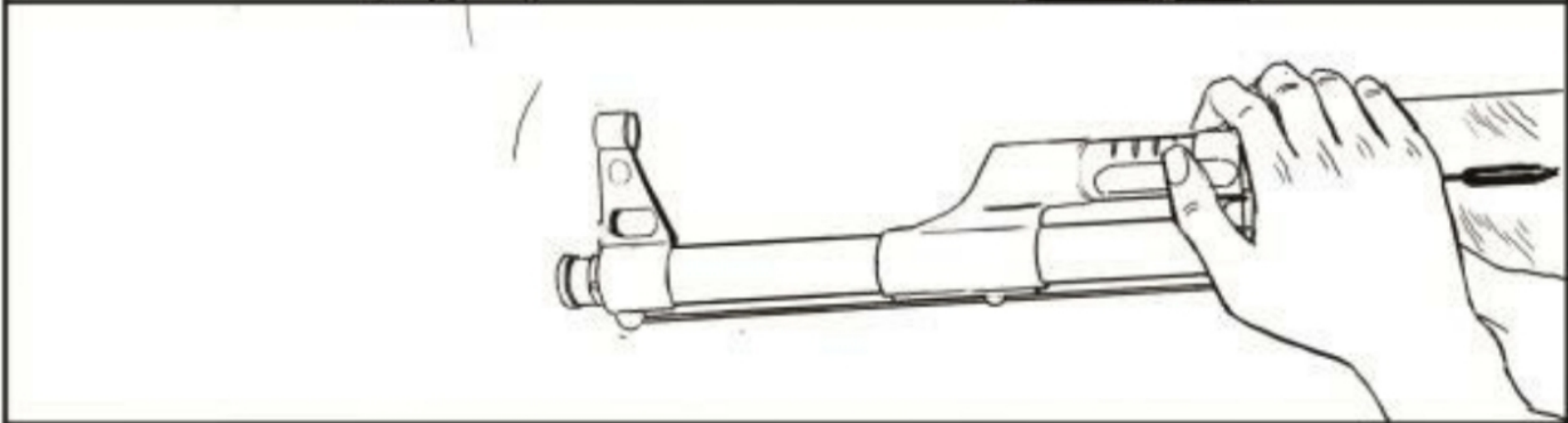
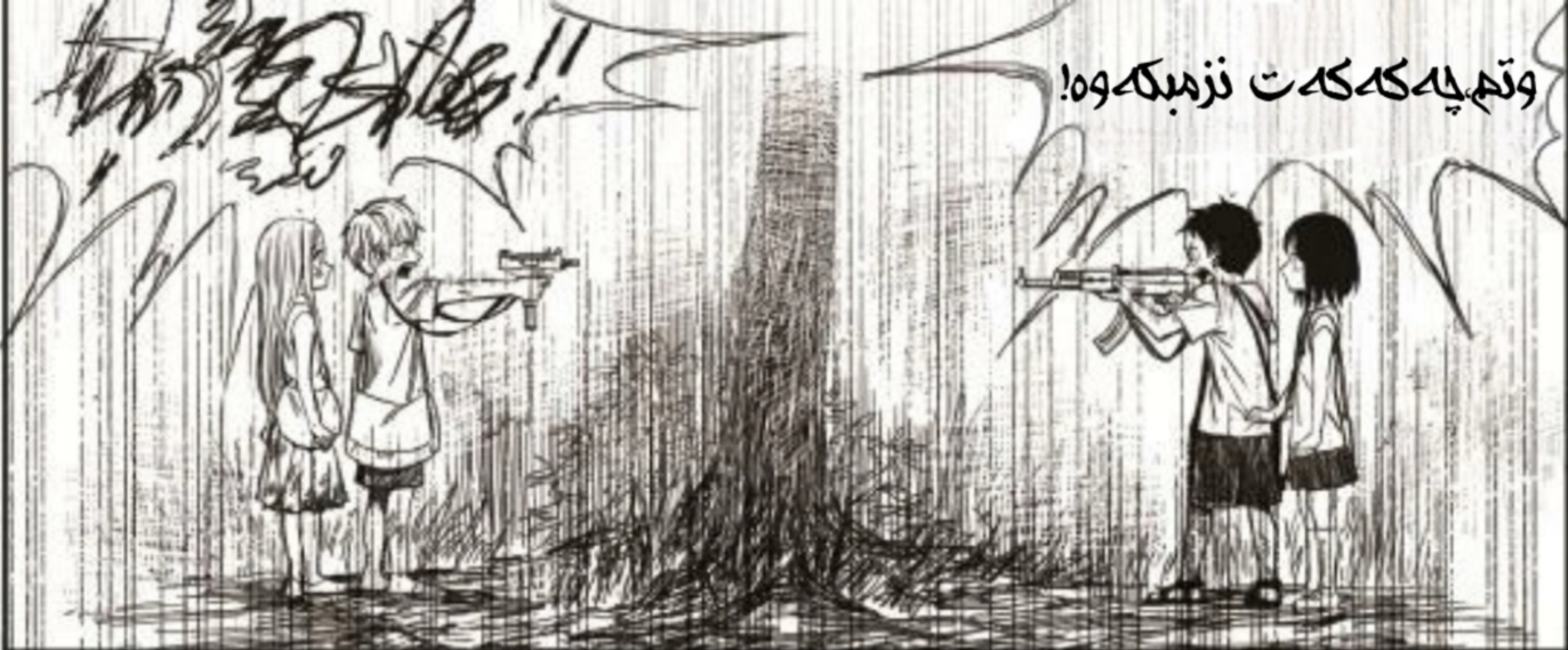









لهوانه پیه



هیشتا هیوایهک هاییت



バム!

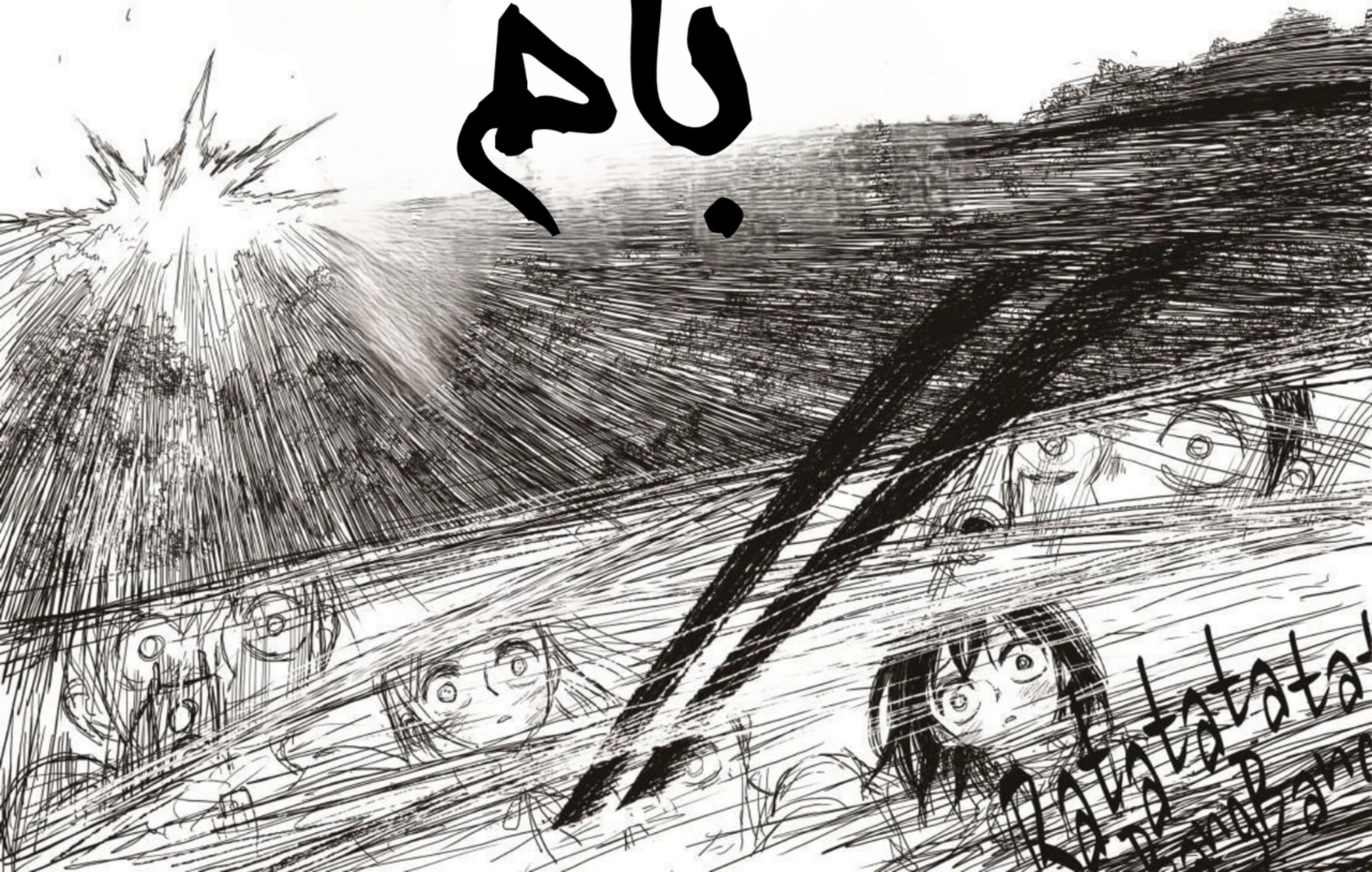

tata tata
tata tata









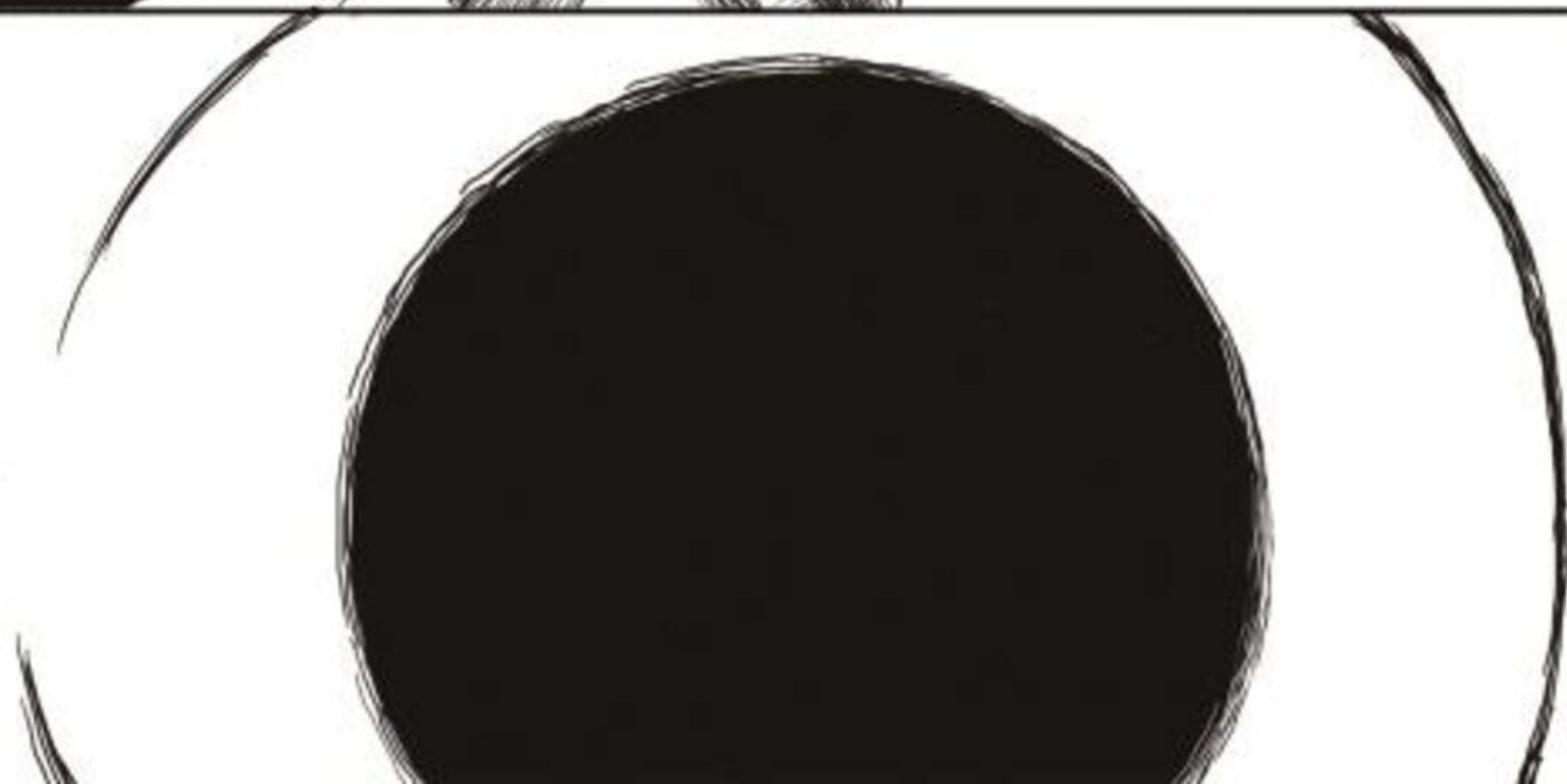



سه پیر کردن



بانگلا۔













بەلئ



ئىھە دەجولپىن



بۇ پىشەوہ...



بۇ پېشەوہ...





بۇ پېشەۋە...









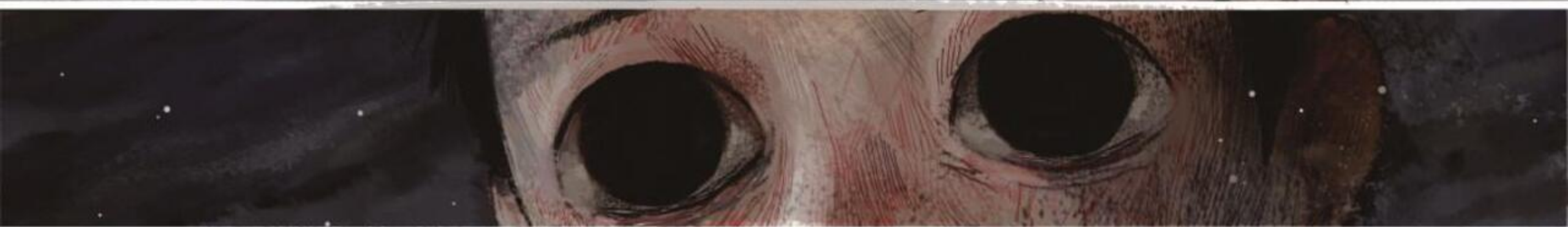









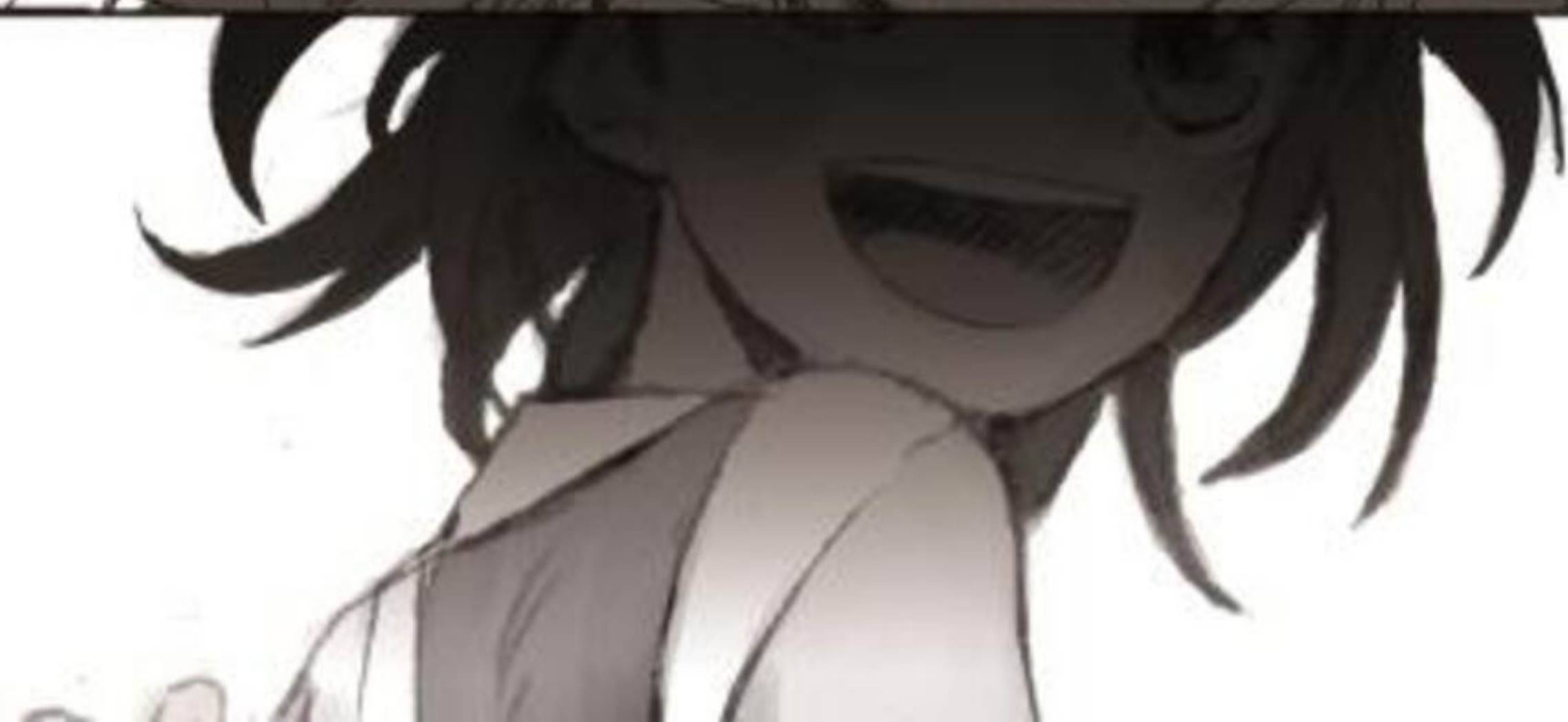
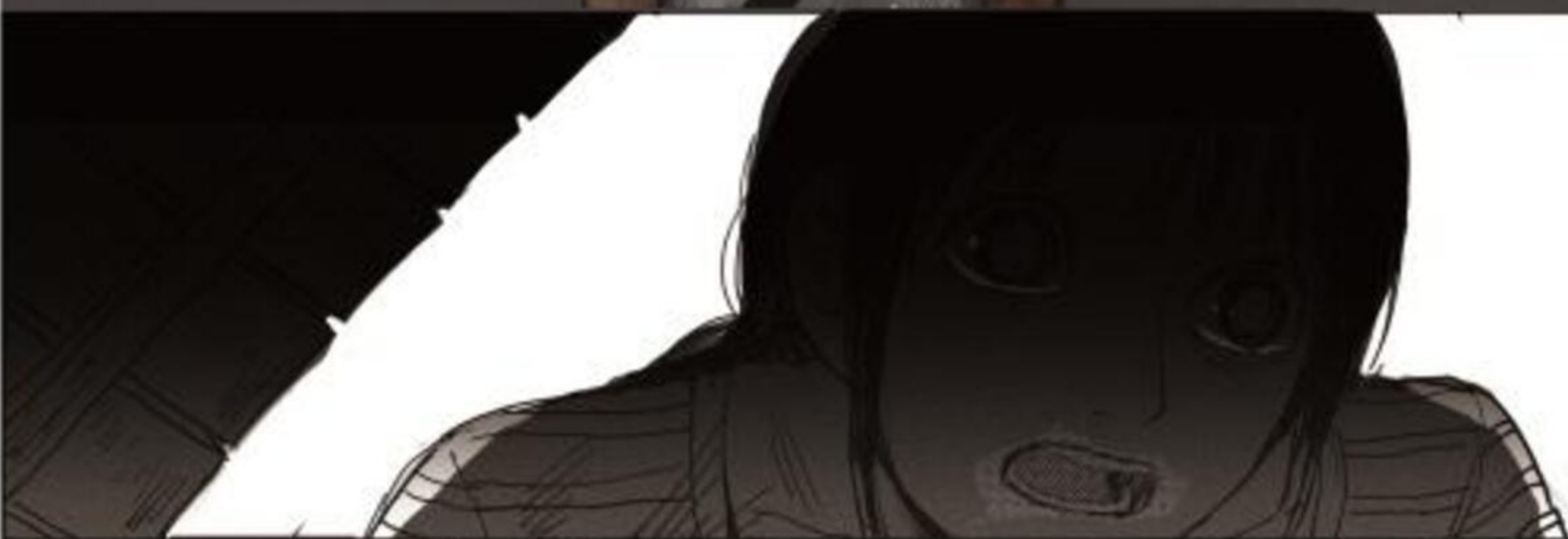



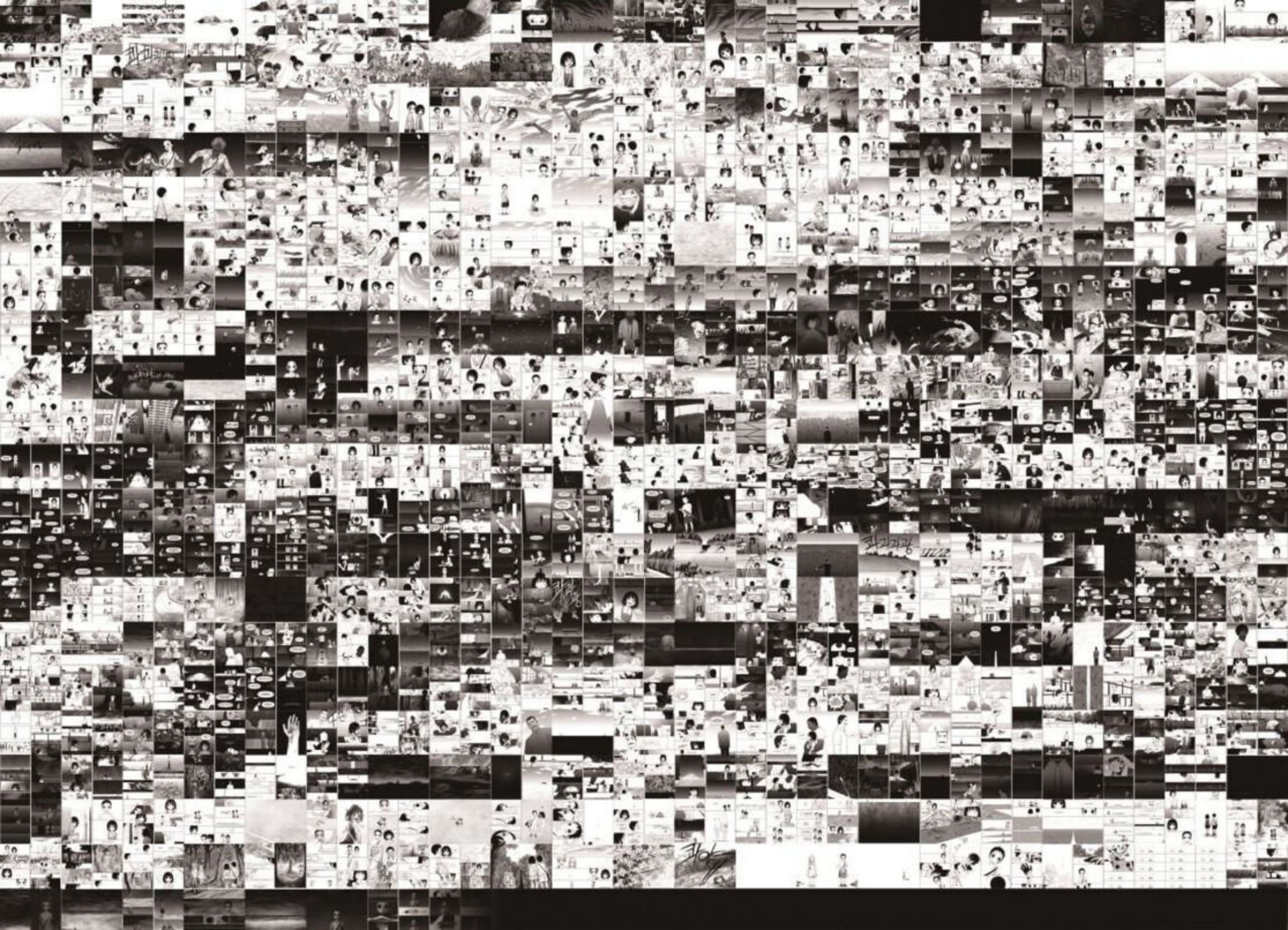





















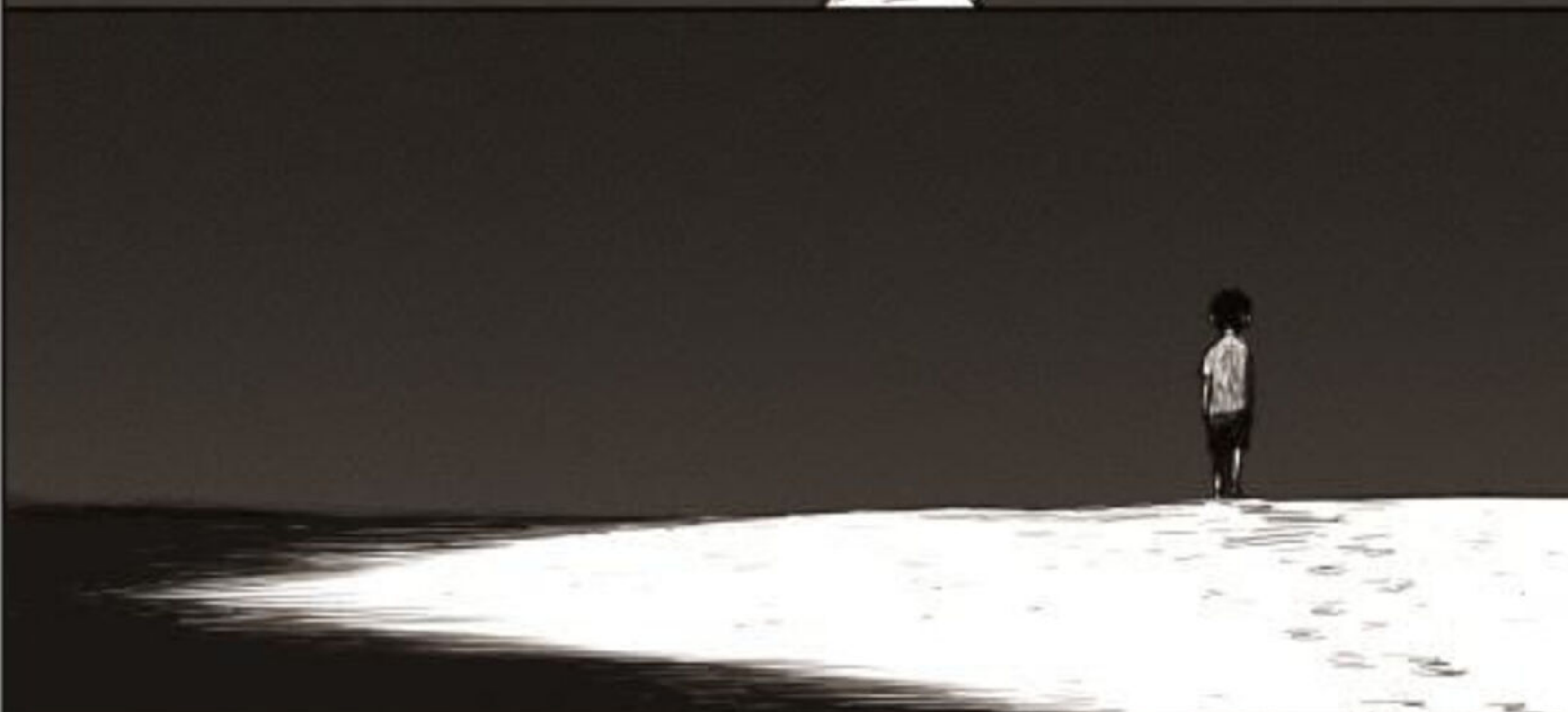

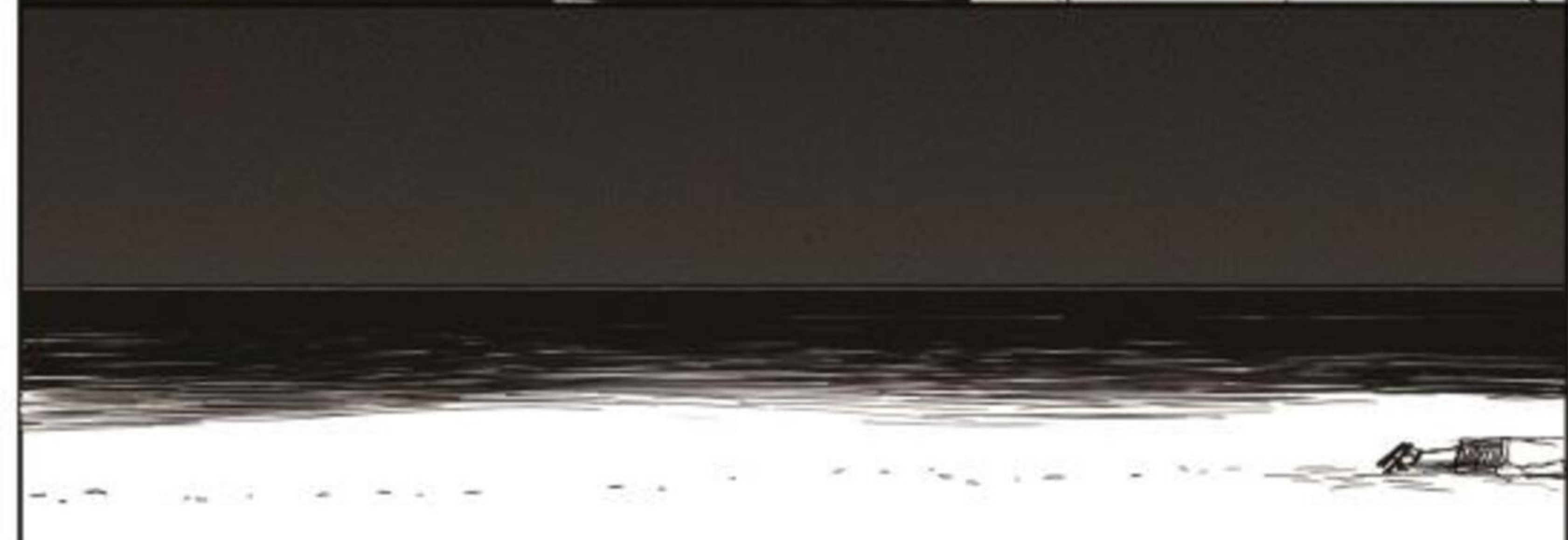

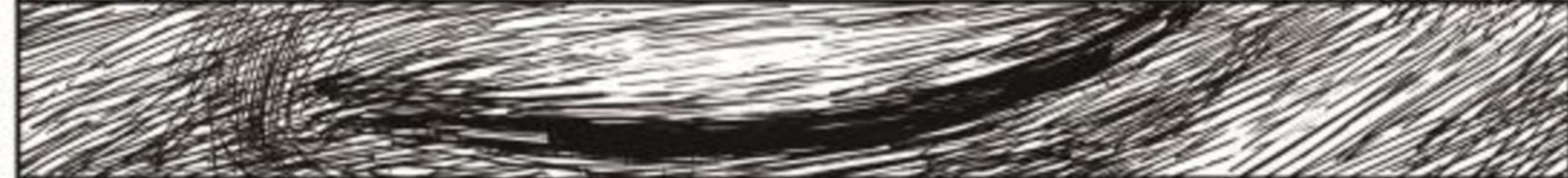





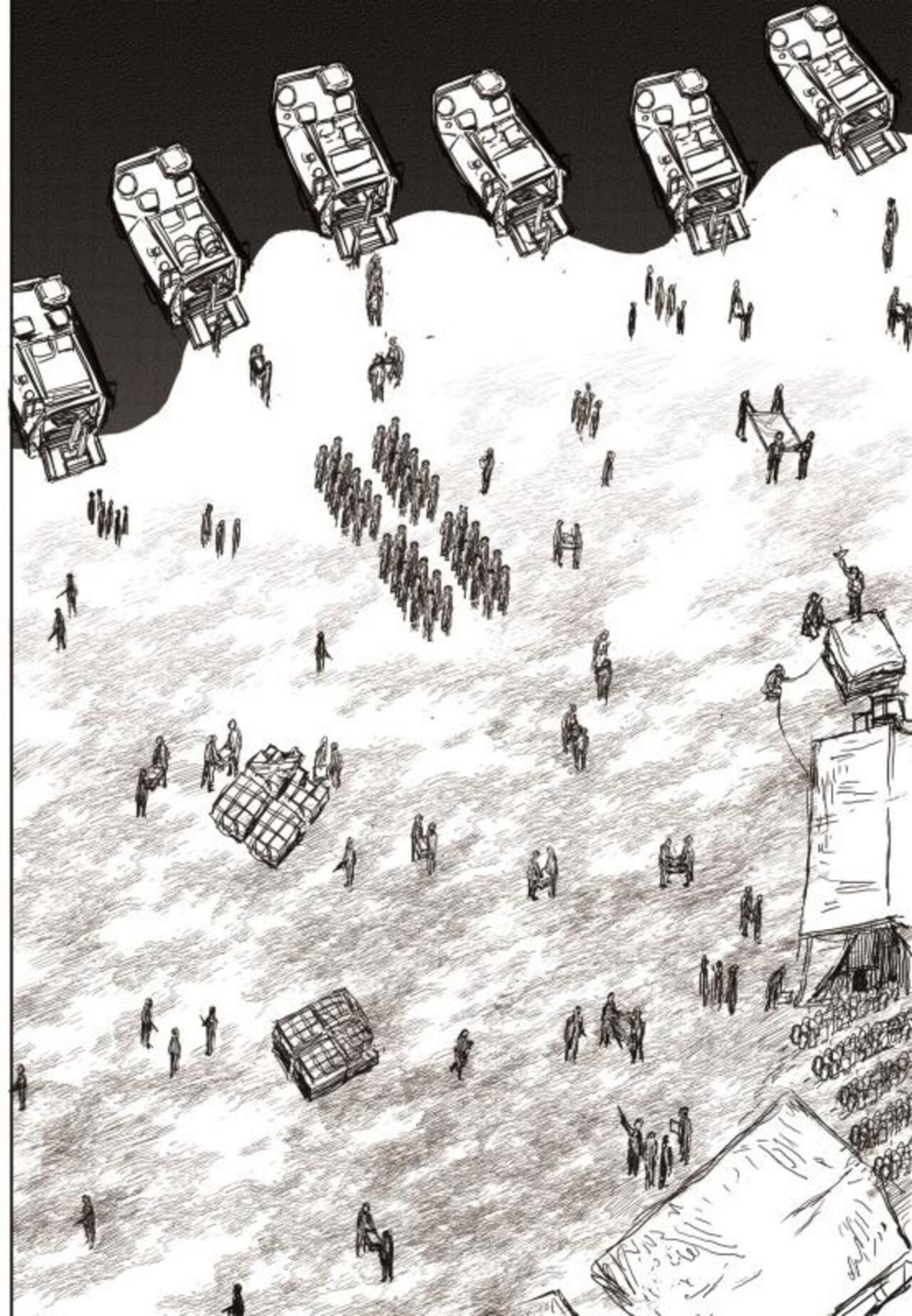

قرش کر وتی ...

هرموو شتیک بیسوورده، بی سوورده، بی سوورده...
هرموو شتیک بیسوورده.